



Nicolai Sebastian Szeliga (Autor)

Investigation and Modelling of Vortex Development and Gas Entrainment in Pump Intakes under Critical Inflow Conditions

Berichte aus dem Institut für Mehrphasenströmungen
Herausgegeben von Prof. Dr.-Ing. habil. Michael Schlüter

6

Nicolai Sebastian Szeliga, M.Sc.

Investigation and Modelling of Vortex Development and Gas Entrainment in Pump Intakes under Critical Inflow Conditions



Cuvillier Verlag Göttingen
Internationaler wissenschaftlicher Fachverlag



<https://cuvillier.de/de/shop/publications/8212>

Copyright:

Cuvillier Verlag, Inhaberin Annette Jentzsch-Cuvillier, Nonnenstieg 8, 37075 Göttingen, Germany

Telefon: +49 (0)551 54724-0, E-Mail: info@cuvillier.de, Website: <https://cuvillier.de>



1 Introduction

The occurrence of gas-entraining free surface vortices at pump intakes poses a huge safety hazard for the reliable operation of cooling circuits in chemical and power plants. Without proper safety precautions, entrained gas will accumulate inside the system and cause the breakdown of coolant flow as well as long-term damage through cavitation inside pumps, valves and heat exchangers.

Furthermore, free surface vortices are the cause of problems in many other fields of operation, since they can occur anywhere, where liquids are drained from reservoirs, e.g. the sump of a rectification column, storage tanks for chemical processes and even at hydro-electric power turbines.

Vortex formation is a complex topic, depending on many different parameters, like reservoir size and shape, volume flow rate, liquid level, induced momentum and fluid properties. The phenomena of vortex development, the fluid mechanics behind it and the existing theoretical vortex models and safety correlations will therefore be discussed in detail in chapter 2. Numerous groups from a diverse range of scientific and engineering fields have conducted research, both experimental and theoretical, on this topic with different approaches and varying degrees of success. Through their culminated effort a plethora of vortex models and correlations has been developed over the last decades, of which none can be applied universally so far. Most models and correlations are either too oversimplified, limited in their use for certain applications or too complex to be useful in practice.

Advancements in the field of optical measurement techniques as well as increased computational power in the recent decade enable a more sophisticated approach on the experimental and numerical examination of vortex formation. With the help of the thereby gained research data the existing models and correlations can be evaluated and, if deemed useful, enhanced to provide more accurate predictions of the vortex development and the risk of gas entrainment.



1.1 Research Goals

The work conducted within this thesis is performed as part of the project SAVE: “*Safety-relevant analysis of the performance of centrifugal pumps, valves and inlet geometries, including stress-related events*” (German: Verbundprojekt SAVE: „*Sicherheitsrelevante Analyse des Verhaltens von Armaturen, Kreiselpumpen und Einlaufgeometrien unter Berücksichtigung störfallbedingter Belastungen*”, German Federal Ministry of Education and Research (BMBF), grant number 02NUK023A). The research goals of this thesis are to evaluate the existing vortex models and correlations and to improve suitable models towards a more practical usability. Further, design criteria are investigated and ranked, based on their impact on the vortex development and recommendations for the design of pump intakes are developed.

For the experimental investigation of the vortex formation, a large-scale pilot plant is constructed in the experimental hall of the Hamburg University of Technology (TUHH) as well as a smaller, geometrical similar laboratory setup. Experiments include the measurement of gas-core lengths, velocity fields and profiles of free surface vortices. Investigated variables besides the scale are: Volume flow, liquid level, pump intake size and shape and induced circulation. The experimental setup as well as the conducted experiments are described in detail in chapter 3, the results and discussion can be found in chapter 4.

2 Theoretical Background

In this chapter the phenomenon of vortex formation is described in detail, from the fundamentals of vortex development and fluid dynamics up to vortex scaling criteria and vortex preventing devices. A focus is set on prior research conducted by other research groups, including their vortex models and correlations for critical submergence depths, emphasizing on models and correlation which are applicable for the experimental setup used in this thesis.

2.1 Fundamentals of Vortex Development

In fluid dynamics, a vortex is a coherent structure within a moving fluid, with a strong rotational flow. Intake vortices are a specific form of vortices forming around an axial downdraft, often caused by the pressure drop of an outflow of liquid from a reservoir. At first the liquid is flowing towards the downdraft in radial direction, but due to asymmetries in the flow, the liquid starts to rotate with increasing azimuthal velocity towards the center of the downdraft, thus forming an intake vortex [Nog03]. The main causes for asymmetric flow are design based, like an eccentric flow around a corner or obstacle as well as velocity gradients in the approaching flow, due to viscous friction on the reservoir walls, see Figure 2-1 for a graphic display of the main causes [Hec78].

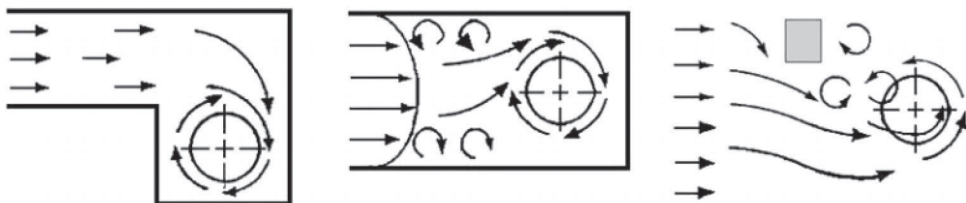

Figure 2-1: Sources of flow circulation (From left to right: (i) eccentricity, (ii) velocity gradient, and (iii) obstruction (adapted from *Hecker & Durgin, 1978*) [Auc09].



Vortices can be classified in three different ways according to *Knauss*: The point of origin, the shape and the duration of occurrence. Rotation free vortices, also called concentric vortices, occur on resting liquid surfaces when the submergence depth is small in proportion to the intake opening size. Rotating vortices can occur either on free liquid surfaces or as submerged vortices on walls and floors within the liquid body, see Figure 2-2 and Figure 2-3 for a schematic visualization of the vortex types.

Submerged vortices do not cause gas entrainment but may introduce angular momentum into the pump intake. Rotating vortices on the liquid surface, also called free surface vortices, can cause both momentum and gas entrainment into the pump intake [Kna83]. Furthermore, all forms of vortices can be divided into steady and unsteady vortices [Gül13].

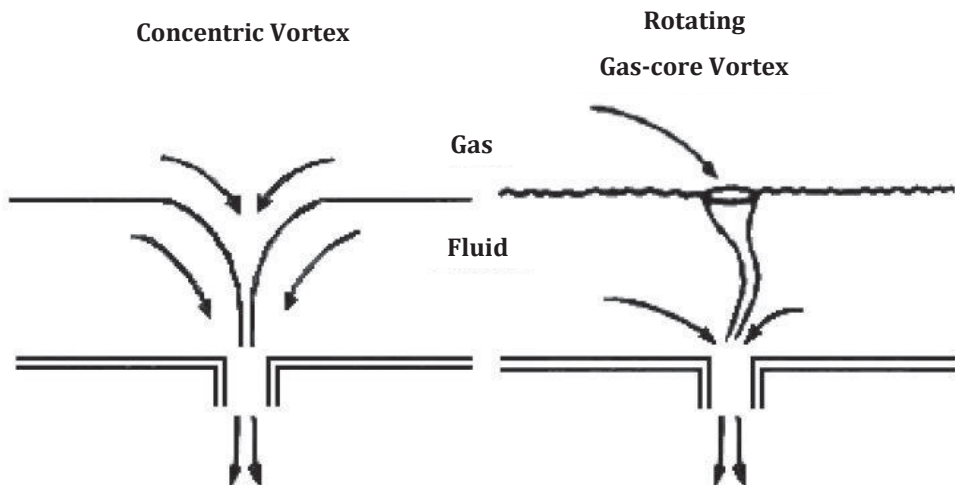

Figure 2-2: Schematic visualization of surface vortices according to *Knauss* [Rei82].

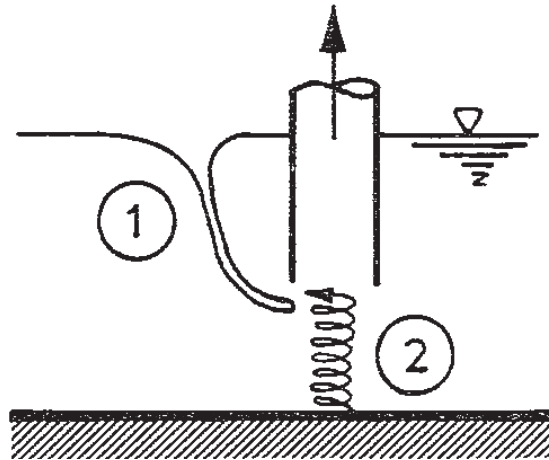

Figure 2-3: Schematic visualization of rotating vortex types: (1) Free surface vortex, (2) submerged vortex [Kna83].

Free rotating surface vortices can be classified further by their strength, most visible by the length of the formed gas core, see Figure 2-4. The vortices can be separated into six different strength levels, based on their gas-core lengths. The lowest vortex strength level is 1, where neither a gas-core nor rotation on the surface are visible yet and only subsurface rotation occurs. Level 2 sees the start of surface rotation as well as the formation of a surface dimple, while at level 3 a fully developed gas-core is visible. Level 3 also marks the development stage, where the invisible vortex core first reaches into the pump intake, which can be visualized by dye-core experiments. Vortices of strength level 4 have a longer gas-core and particles (if present in the fluid) start to accumulate at the gas-core tip. Gas-entrainment into the pump systems start at vortex strength level 5, where gas-bubbles separate from the gas-core tip. Level 6, marks critical vortex conditions, where the gas-core reaches into the pump intake and gas is entrained continuously. Vortices of the levels 1 to 4 are generally tolerable for the operation of a pump system since they only introduce momentum to the system. Vortices of level 3 and 4 should still be avoided if possible, since they can lead to the entrainment of solid objects into the system, which can clog pipes or damage pumps. Vortices of level 5 and 6 are to be avoided, as they are the cause for gas entrainment into the system, which can accumulate in the pump impeller and cause cavitation damage and the collapse of the flow rate [Hec78]. See Figure 2-5 for an example of a level 6 vortex, recorded in the pilot plant setup.

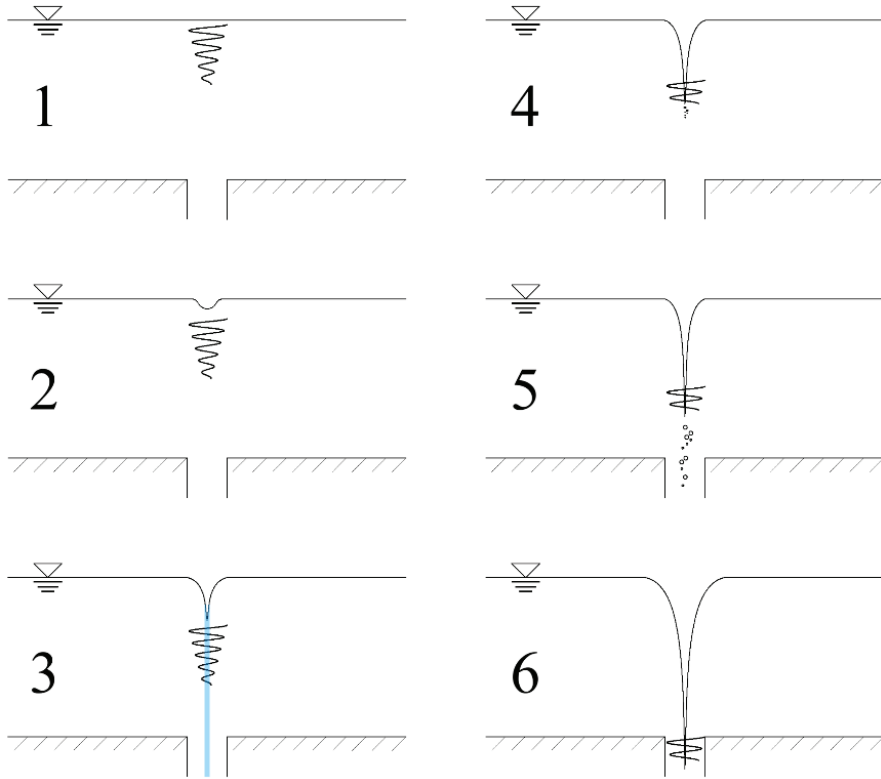

Figure 2-4: Classification of vortex strengths according to *Hecker & Durgin*. 1. Subsurface rotation, 2. Forming of first surface dimple, 3. Vortex-core reaches into the pump intake, 4. Entrainment of particles at the gas-core tip, 5. Start of gas (bubble) entrainment into the pump intake, 6. Critical vortex condition – Gas-core reaches into the pump intake [Hec78].

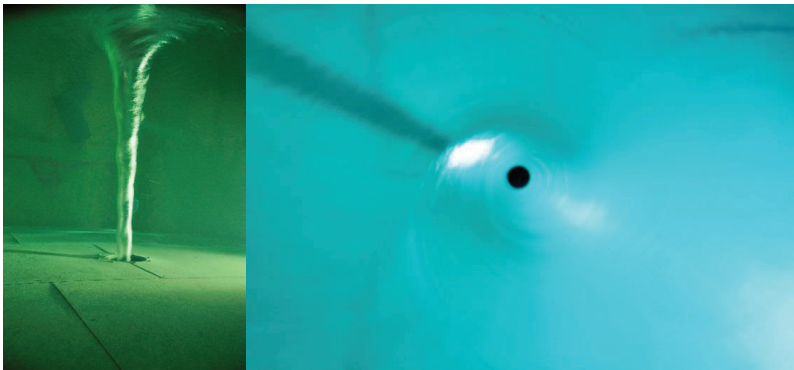

Figure 2-5: Photograph of a level 6 vortex with fully developed gas-core. Recorded in the pilot plant setup. Left: side view, right: Top view.



2.1.1 Parameters and Dimensionless Numbers

To be able to correctly describe the vortex development, either with theoretical models (see subchapter 2.2) or empirical correlations (see subchapter 2.3), the relevant parameters for the vortex development must be identified. The parameters can be divided into fluid dynamic properties and geometrical parameters. Fluid properties are:

- Density ρ ,
- Viscosity - kinematic ν or dynamic μ ,
- Surface tension σ ,
- Circulation Γ (a measure for the vortex strength, see p. 9),
- Submergence depth S (the height of the water level above the pump intake),
- Intake velocity u and volume flow rate Q .

The relevant geometrical parameters are the intake shape and intake pipe diameter d , the orientation of the intake (horizontal, vertical upwards or downwards, traverse), the size and shape of the intake chamber, whether the intake is connected to the wall or protrudes into the chamber and whether vortex breakers (see subchapter 2.5) are used [Jai78, Kna83].

An important parameter to determine the influence of vortex development on a pump system is the critical submergence depth S_{crit} . The critical submergence depth is defined as the depth, for which a gas-core vortex would reach the pump intake [Jai78].

By combining the correct parameters, dimensionless number can be used to compare different designs and sizes. Important dimensionless numbers are the Froude number

$$Fr = \frac{u}{\sqrt{g \cdot D}} \quad (2-1),$$

which describes the inertial to weight force ratio of a fluid system, with g as the gravitational acceleration, the Reynolds number

$$Re = \frac{u \cdot D}{\nu} \quad (2-2),$$

describing the ratio of inertial to viscous forces, and the Weber number

$$We = u \cdot \sqrt{\frac{\rho \cdot D}{\sigma}} \quad (2-3),$$



which defines the ratio of inertial to surface tension forces. Further, the dimensionless circulation

$$\Gamma^* = \frac{\Gamma \cdot D}{Q} \quad (2-4),$$

also known as the circulation number, and the dimensionless submergence

$$S^* = \frac{S}{D} \quad (2-5),$$

are used for the description of vortices in intake systems [Kna83].

In this thesis, another dimensionless quantity is introduced. Dividing the gas-core length L by the submergence depth S , yields the dimensionless gas-core length

$$L^* = \frac{L}{S} \quad (2-6),$$

with values between 0, where no gas-core has formed yet, and 1, where the gas-core reaches the pump intake and $S = S_{\text{crit}}$. The dimensionless gas-core length is used to compare the different experimental sizes and submergence depths with each other. [Sze16]



2.2 Theoretical Vortex Models

The calculation of the vortex fluid dynamics in pump intakes and the correct prediction of the occurring gas core lengths and amount of entrained gas is challenging, due to the complex three-dimensional flow and the vast amount of intake geometries and sizes. There have been many attempts to develop a unified vortex model for all possible cases, but so far, no universally applicable model has been found. In the following chapters the most widely used vortex models are described and their strengths and shortcomings are explained. While most models are shortly summarized, the model of *Burgers & Rott*, used for the evaluation, is explained in detail, see chapter 2.2.3.

2.2.1 Rankine Model

This mathematical vortex model is the first vortex model, proposed in 1858 by *William. J. M. Rankine*. It is the basis for many following vortex models and still in use today, due to its simplicity, i.e. *Keller et al.* [Kel14]. According to *Rankine*, the vortex can be divided into two regions. The vortex core region, which behaves like a rigid body rotation and the outer vortex, which behaves like an irrotational vortex. For the regions, *Rankine* defined two separate equations for the azimuthal velocity

$$u_{\theta} = \begin{cases} \frac{\Gamma_{\infty}}{2\pi} \cdot \frac{r}{r_0^2} & \text{for } r \leq r_0 \\ \frac{\Gamma_{\infty}}{2\pi r} & \text{for } r > r_0 \end{cases} \quad (2-7)$$

over the radius r . With r_0 as the radius of the vortex core and Γ_{∞} as the circulation outside the vortex region, also called the bulk circulation. Since the azimuthal velocity and its decrease is slow in the outer regions of the vortex (bulk phase), the bulk circulation can be seen as a constant value independent of the vortex radius r . The azimuthal velocity profile over the radius can be seen in Figure 2-6. Inside the core region, the azimuthal velocity is raising linear, until the border of the vortex core is reached. Outside the core region the velocity is then decreasing hyperbolically.

The bulk circulation is calculated by integrating the azimuthal velocity over a circle line C

$$\Gamma_{\infty} = \oint_C u_{\infty} \cdot dC \quad (2-8),$$

where u_{∞} is the velocity vector and dC the azimuthal circle line [Ran58]. See Figure 2-7 for an exemplified view.

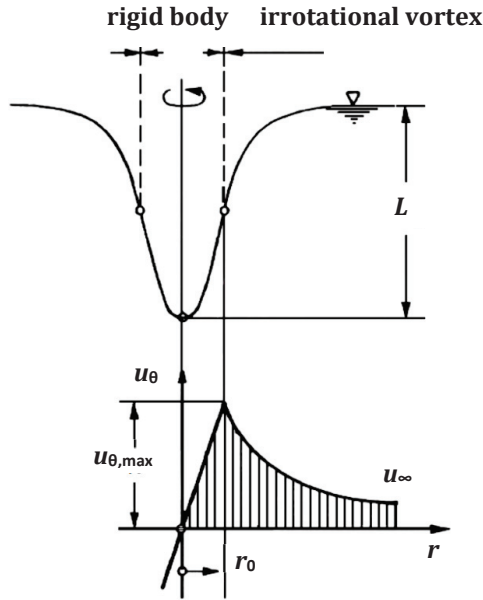

Figure 2-6: Schematic view of the Rankine vortex model with the course of the azimuthal velocity profile over the radius and the profile of the liquid surface above, with L as the resulting gas core length [Kna83].

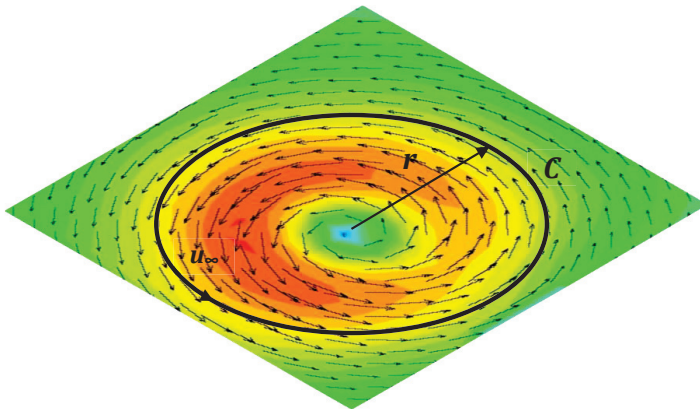

Figure 2-7: 2D-Particle Image Velocimetry measurement plot of a free surface vortex, with the circle line C , the radius r and the velocity along the circle line u .